



International
Association of
Exhibitions and Events®

Guidelines for Display Rules and Regulations

Updated for Institute for Healthcare Improvement (IHI)



Made possible by a generous grant from

Freeman

The following **Guidelines for Display Rules and Regulations** have been established by the International Association of Exhibitions and Events® (IAEE) to assist in promoting continuity and consistency among North American exhibitions and events. This revised 2023 edition is offered as a resource for exhibition and event organizers to use in creating consistent and fair exhibiting standards for their events.

Recognizing that every show is unique, IAEE presents the information contained within as recommendations or suggestions for exhibiting standards each Organizer should consider. Organizers are encouraged to review the **Guidelines** and then develop their own show-customized set of exhibiting rules and regulations based on the individual features of their specific exhibition or event.

Once an Organizer has finalized their show's official set of display rules, it is good practice to provide access to a digital copy within the show's exhibitor prospectus, an exhibitor services kit, and the official rules and regulations pertaining to exhibitor participation. By providing exhibitors with the professional standards expected of their displays and participation, they will be prepared to properly design, build and plan their booth's layout and content allowing for an environment where all exhibitors will have the opportunity for successful interaction with their audiences.

Important Note: Although compliance with fire, safety, the U.S. Americans with Disabilities Act (ADA), and other state, federal or provincial government requirements have been addressed, Organizers should always check with exhibition service contractors and the facility for specific details on local regulations and requirements.

*IAEE is a global association that serves as the foremost authority on exhibitions and events management and operations, and these **Guidelines** are the model for most North American exhibitions and events but in all instances, organizations should consult their legal counsel. In no event shall IAEE be held liable for damages of any kind in connection with the material, methods, information, techniques, opinions or procedures expressed, presented, or illustrated in these **Guidelines** or related materials.*



International
Association of
Exhibitions and Events®

TABLE OF CONTENTS

LINE-OF-SIGHT STYLE	1
Linear or In-line Booth	1
Dimensions	1
Use of Space	1
Corner Booth.....	2
Perimeter Booth	2
Dimensions and Use of Space	2
End-cap Booth	3
Dimensions and Use of Space	3
Peninsula Booth.....	4
Dimensions and Use of Space	4
Split Island Booth.....	5
Dimensions and Use of Space	5
Island Booth	6
Dimensions and Use of Space	6
Extended Header Booth 20ft (6.10m) or Longer	7
Dimensions and Use of Space	7
Remote-Controlled Devices	8
OTHER IMPORTANT CONSIDERATIONS	8
Canopies and Ceilings	9
Structures and Tie-Offs	10
Structures.....	10
Tie-offs	10
Hanging Signs and Graphics	10
Teardrop Signs and Tents.....	10
Truss	11
Video Displays	11
Towers and Multi-story Exhibits	11
U.S. Americans with Disabilities Act (ADA).....	11

TABLE OF CONTENTS

ISSUES COMMON TO ALL BOOTH TYPES 11

- Structural Integrity 12
- Flammable and Toxic Materials 12
- Hazardous Waste..... 12
- Storage..... 12
- Electrical..... 13
- Lighting..... 13
- Demonstrations 14
- Sound/Music 14
- Vehicles (For Both Gas and Electric Vehicles) 15
- Fire Equipment..... 15
- Hanging Signs..... 15

ADVISORY NOTES TO EXHIBITION ORGANIZERS 15

- Hardwall Booths..... 16
- Perimeter Openings 16
- Pipe and Drape 16
- Product Height 16
- Height Variances..... 16
- Environmental Responsibility 16

APPENDIX 17

IAEE EXTENDS A SPECIAL THANK YOU TO THE FOLLOWING VOLUNTEERS FOR THEIR INPUT..... 28

IAEE has identified two distinctly different styles of show display regulations. One style is “Line-of-Sight” while the second is “Cubic Content.” Organizers should decide which style is best suited to their event or designated section of the event. Organizers might find line of sight rules are best for linear booths and cubic content rules for configurations of island, peninsula or perimeter booths.

LINE-OF-SIGHT

Line-of-Sight display rules provide restrictions on certain areas of booths to allow attendees to view neighboring booths in their line of sight as they walk the floor. There are a variety of booth types, and each one is addressed below with specific insight on how to implement Line-of-Sight regulations.

LINEAR OR IN-LINE BOOTH

services easily seen by attendees as they walk the aisles is essential to all exhibitors, and that is the basis for including a Linear Booth Line-of-Sight setback rule. Linear Booths, also called “in-line” booths, are generally arranged in a straight line and have neighboring exhibitors on their immediate right and left, leaving only one side exposed to the aisle.

Dimensions

For purposes of consistency and ease of layout and/or reconfiguration, floor plan design in increments of 10ft (3.05m) has become the de facto standard in the United States. Therefore, unless constricted by space or other limitations, Linear Booths are most

commonly 10ft (3.05m) wide and 10ft (3.05m) deep, i.e. 10ft by 10ft (3.05m by 3.05m). A maximum back wall height limitation of 8ft (2.44m) is specified to prevent display materials from imposing on neighboring exhibits behind the back wall.

Use of Space

Regardless of the number of Linear Booths utilized, e.g. 10ft by 20ft (3.05m by 6.10m), 10ft by 30ft (3.05m by 9.14m), 10ft by 40ft (3.05m by 12.19m), etc., display materials should be arranged in such a manner so as not to obstruct sight lines of neighboring exhibitors. The maximum height of 8ft (2.44m) is allowed only in the rear half of the booth space, with a 4ft (1.22m) height restriction imposed on all materials in the remaining space forward to the aisle. Note: When three or more Linear Booths are used in combination as a single exhibit space, the 4ft (1.22m) height limitation is applied only to that portion of exhibit space which is within 10ft (3.05m) of an adjoining booth.

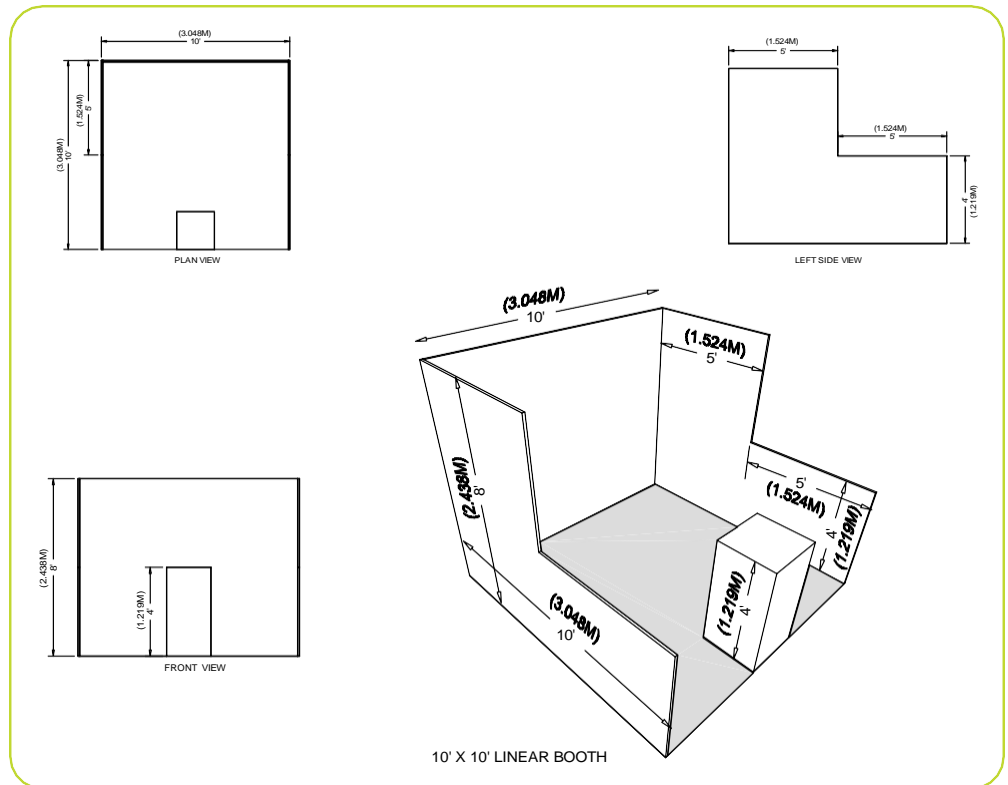

CORNER BOOTH

A Corner Booth is a Linear Booth at the end of a series of in-line booths with exposure to intersecting aisles on two sides. All guidelines for Linear Booths apply.

PERIMETER BOOTH

A Perimeter Booth is a Linear Booth that backs to an outside wall of the exhibit facility rather than to another exhibit.

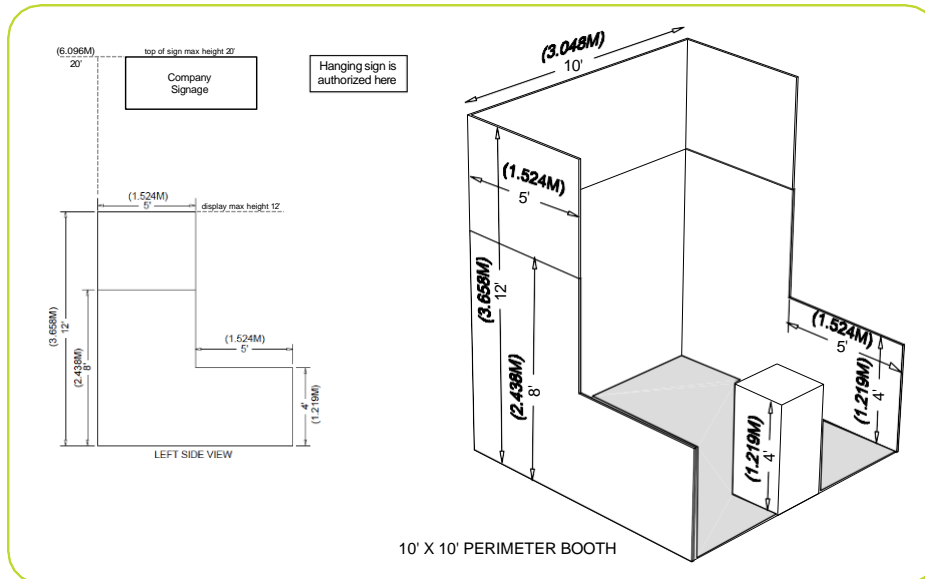

Dimensions and Use of Space

All guidelines for Linear Booths apply to Perimeter Booths except that the typical maximum back wall height for Perimeter Booths is 12ft (3.6m).

END-CAP BOOTH

An End-cap configuration is essentially an in-line (linear) booth placed in the position of a Peninsula or Split Island. For shows that have Line-of-Sight rules and not Cubic Content, this configuration must follow the dimensions below. Organizers should be alert to exhibitors reserving End-cap configurations to ensure they do not violate Linear Booth Line-of-Sight regulations for neighboring exhibits. (In most cases, this booth style is not recommended due to the Line-of-Sight issues, and Organizers should be aware of these challenges when using them.)

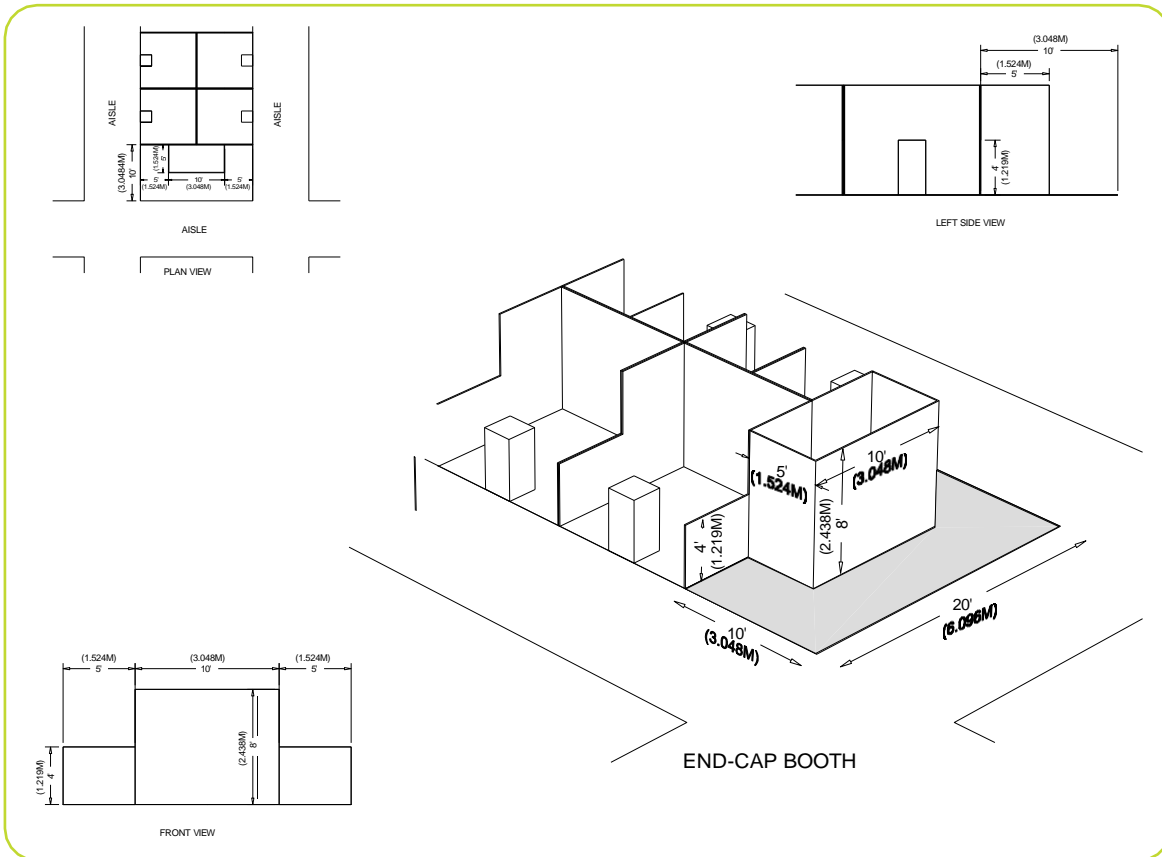

Dimensions and Use of Space

End-cap Booths are generally 10ft (3.05m) deep by 20ft (6.10m) wide. The maximum back wall height allowed is 8ft (2.44m) and the maximum backwall width allowed is 10ft (3.05m) at the center of the backwall with a maximum 5ft (1.52m) height on the two side aisles. Within 5ft of the two side aisles, the maximum height for any display materials is 4ft.

PENINSULA BOOTH

A Peninsula Booth is exposed to aisles on three sides. There are two types of Peninsula Booths: (a) one which backs to Linear Booths, and (b) one which backs to another Peninsula Booth which is referred to as a “Split Island Booth.”

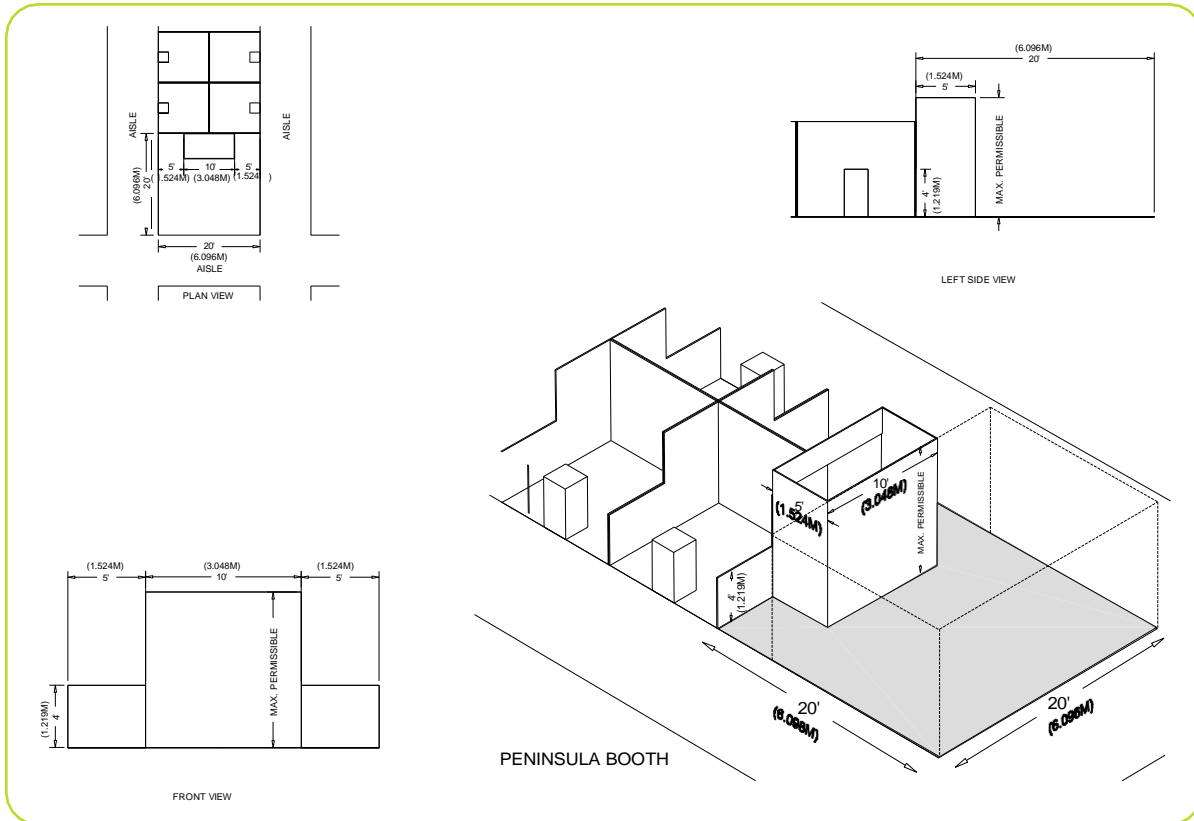

Dimensions and Use of Space

A Peninsula Booth is usually 20ft by 20ft (6.10m by 6.10m) or larger. When a Peninsula Booth backs up to two Linear Booths, the back wall is restricted to 4ft (1.22m) high within 5ft (1.52m) of each aisle, permitting adequate line of sight for the adjoining Linear Booths. A typical maximum height range allowance is 16ft to 20ft (4.88m to 6.10m), including signage for the center portion of the back wall. Double-sided signs, logos and graphics shall be set back 10ft (3.05m) from adjacent booths.

SPLIT ISLAND BOOTH

A Split Island Booth is a Peninsula Booth which shares a common back wall with another Peninsula Booth.

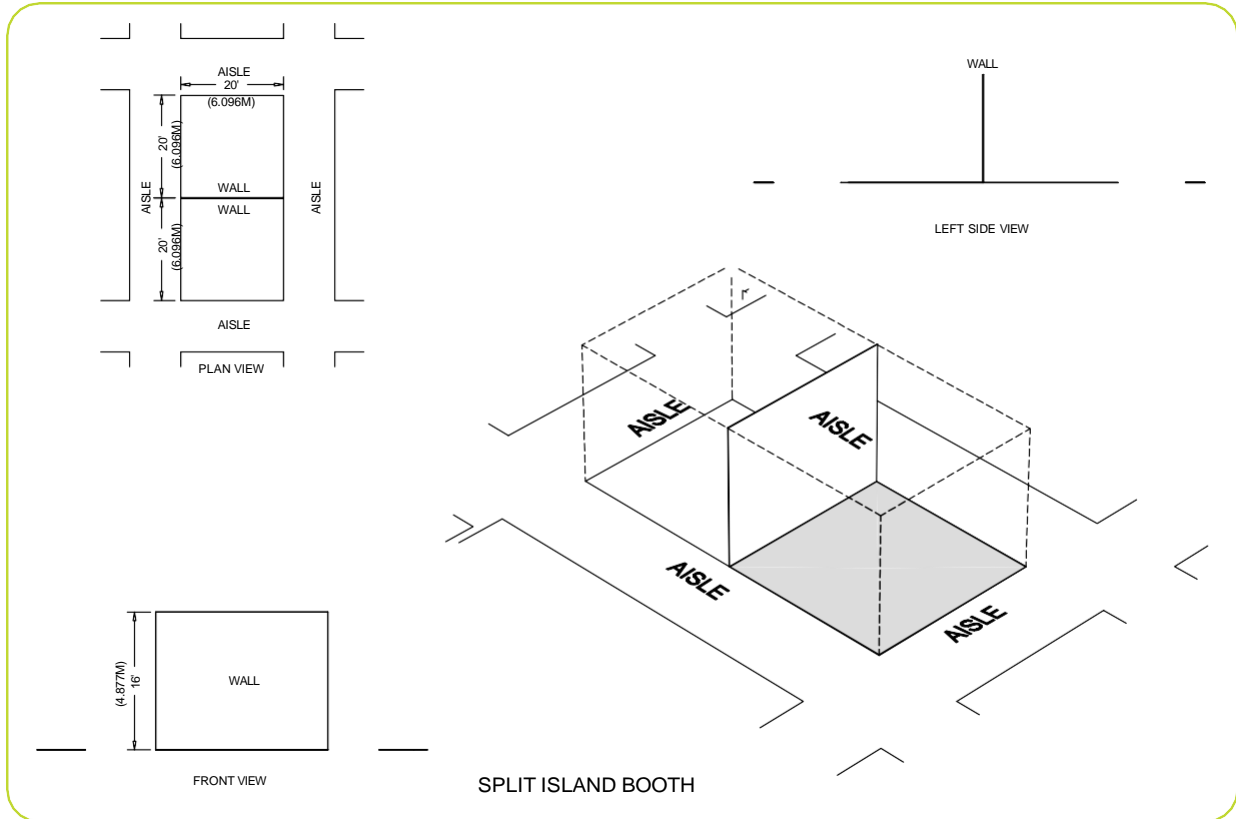

Dimensions and Use of Space

The entire Cubic Content of this booth may be used, up to the maximum allowable height, without any back wall Line-of-Sight restrictions. A typical maximum height range allowance is 16ft to 20ft (4.88m to 6.10m), including signage. The entire Cubic Content of the space may be used up to the maximum allowable height. Double-sided signs, logos and graphics shall be set back 10ft (3.05m) from adjacent booths.

For large shows with big exhibitors, it may be difficult to maintain the entire booth and hanging sign to be within 16ft. If you make it 20 ft then you run the risk of lots of large booths (with or without signs) being 20 ft and dwarfing all around them. That is fine as long as everyone is aware of it. An alternative could be to offer a max booth height of 16 ft and each exhibitor must have a 4 ft gap between the top of the booth and the bottom of the hanging sign. The only exception is if the booth and hanging sign can stay below 16ft. It is far from perfect but does allow at least the ability to see through a booth.

ISLAND BOOTH

An Island Booth is any size booth exposed to aisles on all four sides.

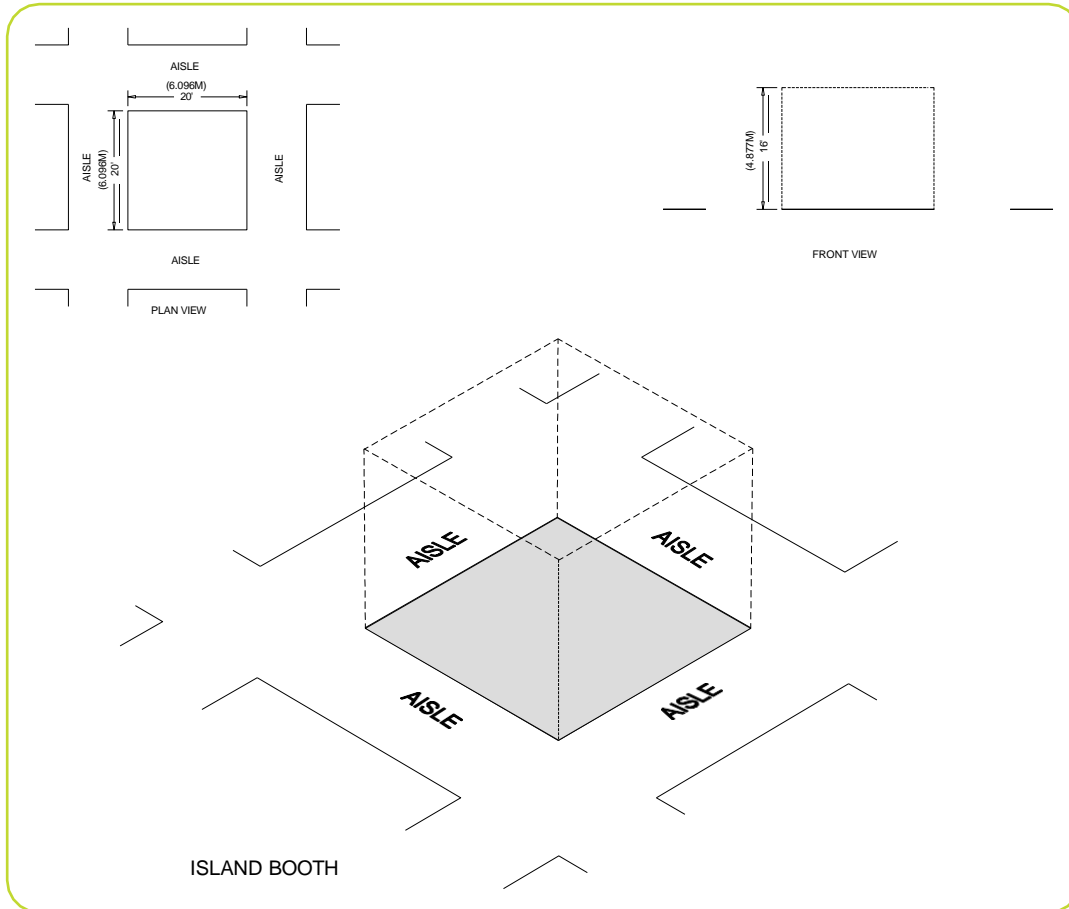

Dimensions and Use of Space

An Island Booth is typically 20ft by 20ft (6.10m by 6.10m) or larger, although it may be configured differently. Island booths should not be allowed at less than 400 sq ft. Island booths at 200 or 300 sq ft basically result in frustrating everyone behind them. The entire Cubic Content of the space may be used up to the maximum allowable height, which is usually a range of 16ft to 20ft (4.88m to 6.10m), including signage.

EXTENDED HEADER BOOTH 20FT (6.10M) OR LONGER

An Extended Header Booth is a Linear Booth 20ft (6.10m) or longer with a center

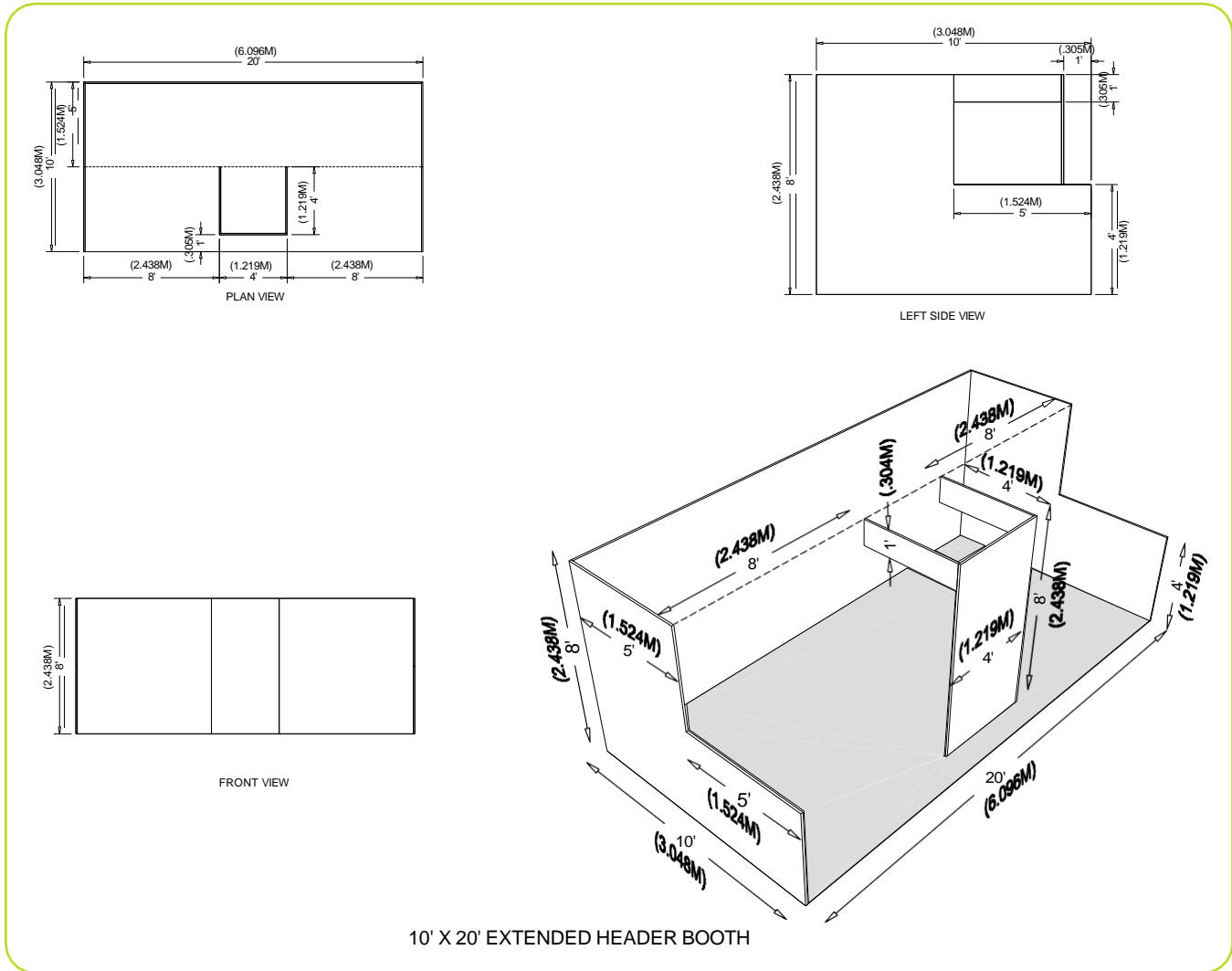

Dimensions and Use of Space

All guidelines for Linear Booths apply to Extended Header Booths, except that the center extended header has a maximum height of 8ft (2.44m), a maximum width of 20 percent of the length of the booth, and a maximum depth of 9ft (2.7m) from the back wall.

OTHER IMPORTANT CONSIDERATIONS

REMOTE-CONTROLLED DEVICES

Products such as remote-controlled cars, drones, planes, helicopters, robots, etc. are to be demonstrated in a safely controlled area of the exhibit floor (i.e. Demonstration Area). When a remote-controlled device is to be used for the purpose of demonstrating a product that requires use of an area outside of the exhibitor-assigned booth space, the Organizer will provide a Demonstration Area for this purpose. The Demonstration Area should include safe netting or other barrier appropriate to accommodate product(s) being demonstrated and be included on the master floor plan submitted for Fire Marshal approval. Each individual facility reserves the right to determine what constitutes a safe and controlled Demonstration Area prior to final plan approval.

NOTE for Drone Operation: Local facility and city ordinances are in effect in most areas and prohibit drone activity near the public or in public spaces. The accepted drone default regulation is the [FAA Small UAS Rule Part 107](#) which requires drone operators to obtain a Remote Pilot Certificate. Commercial regulations often require permits and insurance.

CANOPIES AND CEILINGS

A canopy sign is similar to an awning on a building, except it does not include the goal of providing shelter. It extends from a booth to serve the function as a marquee. Canopies, including ceilings, umbrellas and canopy frames, can be either decorative or functional (such as to shade computer monitors from ambient light or to allow for hanging products). Canopies for Linear or Perimeter Booths should comply with Line-of-Sight requirements. (See "Use of Space" for Linear or Perimeter Booths, and height limits).

The bottom of the canopy should not be lower than 7ft (2.13m) from the floor within 5ft (1.52m) of any aisle. Canopy supports should be no wider than three inches 3in (.08m). This applies to any booth configuration that has a sight line restriction, such as a Linear Booth. Fire and safety regulations in many facilities strictly govern the use of canopies, ceilings and other similar coverings. Check with the appropriate local agencies prior to determining specific exhibition rules.

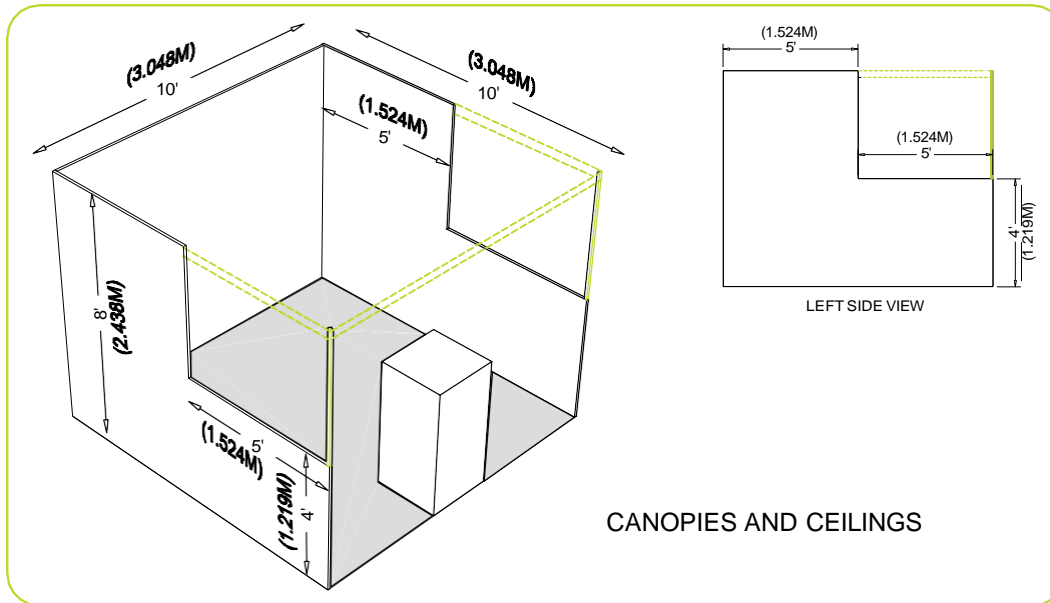

STRUCTURES AND TIE-OFFS

Structures

Show Organizer requires a stamped certification from a design professional (Civil or Structural Engineer) registered in the state where the Event will be held affirming all calculations and specifications for any custom-built suspended elements such as but not limited to non-serially manufactured signs, lightboxes, headers, video wall surrounds, and entry portals. For additional assistance regarding these requirements, please reach out to the rigging vendor.

Tie-offs

Show Organizer reserves the right to request a stamped certification from a design professional (Civil or Structural Engineer) registered in the state where the Event will be held affirming all calculations and specifications and/or a peer review from such registered design professional for attachment of any structure to provide additional support terminating to the venue (Ex. Tie-ff of header, seismic lines, tie-ff of video walls). If you anticipate needing this service, please reach out to the rigging vendor review and pre-authorization.”

HANGING SIGNS AND GRAPHICS

Most exhibition and event rules allow for Hanging Signs and Graphics in all standard Peninsula and Island Booths, usually to a maximum height range of 16ft to 20ft (4.88m to 6.10m) from the top of the sign, or as determined by the Organizer. End-cap Booths do not qualify for Hanging Signs and Graphics. The distance is measured from the floor to the top of the sign. Whether suspended from above, or supported from below, they should comply with all ordinary use-of-space requirements. For example, the highest point of any sign should not exceed the maximum allowable height for the booth type. (An exception to this rule is made for Perimeter Booths, which can have a 12ft [3.66m] backwall but max sign height can be 20ft. [6.10m]. See page 2 Perimeter Booth for diagram.)

Hanging Signs and Graphics should be set back 10ft (3.05m) from adjacent booths and be directly over contracted space only.

Approval for the use of Hanging Signs and Graphics, at any height, should be received from the Organizer at least 60 days prior to installation. Variances may be issued at the Organizer’s discretion. Drawings should be available for inspection.

Sign Hanging Points must be engineered, and the hardware must be domestic, forged, shouldered, rated, and stamped with Working Load Limit (WLL). All overhead rigging must comply with facility and show management regulations. The official contractor and/or facility will require an engineered print of all truss and lighting rigging including rigging point loads, as well as any ground supported truss structures or LED video walls. . All submitted files should be in DWG format. This information is typically required at least three weeks out from the first day of move-in of an event. Electrical signs must be in working order and in accordance with the National Electrical Code. If any hang point exceeds 200 lbs. please notify the official contractor for official authorization.

TEARDROP SIGNS AND TENTS

Placement of Teardrop flags must be positioned in the back ½ of all linear booths.

Tents – must have no copy on the sides or back side and not exceed 8ft height limit. I would also specifically address the tents with extended ceilings, see below. Under no circumstances are these acceptable in a linear booth regardless of whether they have copy or not.

TRUSS

Truss is a frame used to carry a cover over a booth or suspend lighting or technical equipment over a booth. Some shows will allow to go over the height limit but require plans to the organizer and service contractor for approval.

VIDEO DISPLAYS

Show Organizer reserves the right to request approval from a registered design professional (Civil or Structural Engineer) and/ or a peer review from a registered design professional for all non-serially manufactured LED and Video Display systems. All LED and video display systems must comply to ANSI E1.50-1. This applies to ground supported and suspended LED and Video Display systems. If you anticipate needing this service, please reach out to your rigging vendor.

TOWERS AND MULTI-STORY EXHIBITS

A Tower is a free-standing exhibit component separate from the main exhibit fixture. The height restriction is the same as that which applies to the appropriate exhibit space configuration being used. Fire and safety regulations in many facilities strictly govern the use of Towers. A building permit or safety lines may be required.

A Multi-story Exhibit is a booth where the display fixture includes two or more levels. In many cities, a Multi-story Exhibit requires prior approval by the exhibit facility, and/or relevant local government agency, as well as the Organizer because it is deemed to be a “structure” for building purposes. The city building department generally needs to issue a building permit based on an application and drawings prepared and submitted by a licensed architect or engineer. Exhibitors should obtain local building regulations early on to ensure that all time constraints are met. Organizers should be prepared to assist exhibitors in this application process.

It is recommended that Organizers require exhibitors to provide engineering stamped documents for all Multi-story Exhibits and towers over 8ft (2.44m) in height. If engineering stamps are not required, exhibitors using these types of structures should, at a minimum, provide drawings for inspection.

ISSUES COMMON TO ALL BOOTH TYPES

U.S. AMERICANS WITH DISABILITIES ACT (ADA)

In the U.S., all exhibiting companies are required to be in compliance with the U.S. Americans with Disabilities Act (ADA), and are encouraged to be sensitive, and as reasonably accommodating as possible, to attendees with disabilities. Information regarding ADA compliance is available from the U.S. Department of Justice ADA Information Line (800) 514-0301, and from the ADA website at www.ada.gov.

Some examples of how to design an exhibit for ADA compliance:

- Make exhibits wheelchair accessible by ramping raised exhibit flooring without extending a ramp into the aisle. Note: a standard wheelchair ramp should have a grade no steeper than 1:12. This means that for every inch of rise (change in height), there should be 12 inches of run (change in length). Ramps should have a minimum width of 36 inches.
- Ramp the entry or use hydraulic lifts to trailer exhibits.
- Avoid double-padded plush carpet to ease mobility device navigation.
- Provide the same attendee experience on both levels of a two-story exhibit.

- Offer a signer or other auxiliary hearing-impaired apparatus for sound presentations or have a printed copy of the presentation available.
- Run an audio presentation for people with sight problems.
- Arrange touch screen displays at a height to accommodate a person sitting in a wheelchair.

To avoid potential fines by the U. S. Department of Justice, exhibitors must adhere to the ADA rules. Exhibits are not exempt from ADA compliance.

STRUCTURAL INTEGRITY

All exhibit displays should be designed and erected in a manner that will withstand normal contact or vibration caused by neighboring exhibitors, hall laborers, or installation/dismantling equipment, such as fork lifts. Displays should also be able to withstand moderate wind effects that may occur in the exhibit hall when freight doors are open. Refer to local building codes that regulate temporary structures.

It is recommended that all exhibits 20ft by 20ft (6.10m by 6.10m) and larger require a drawing, plans or renderings, preferably digital, to be submitted to the Organizer, and to the show's Official Services Contractor for approval.

Exhibitors should ensure that any display fixtures such as tables, racks, or shelves are designed and installed properly to support the product or marketing materials to be displayed.

FLAMMABLE AND TOXIC MATERIALS

All materials used in display construction or decorating should be made of fire retardant materials and be certified as flame retardant. Samples should also be available for testing. Materials that cannot be treated to meet the requirements should not be used. A flame-proofing certificate should be available for inspection. Exhibitors should be aware of, and must adhere to, all local regulations regarding fire/safety and environment.

Exhibitors should dispose of any waste products they generate during the exhibition in accordance with guidelines established by the

U.S. Environmental Protection Agency, or the appropriate government entity in the country the exhibition will be held, and the facility.

HAZARDOUS WASTE

Hazardous waste requires special arrangements to be prepared in advance of event dismantle with either the facility or a local independent disposal company. Exhibitors are responsible for all costs associated with such specialized removal.

STORAGE

Fire regulations in most exhibit facilities prohibit storing product, literature, empty packing containers, or packing materials behind back drapes or under draped tables. In most cases, however, exhibitors may store a limited supply of literature or product appropriately within the booth area, as long as these items do not impede access to utility services, create a safety problem, or look unsightly.

ELECTRICAL

Every exhibit facility has different electrical requirements and rules regarding who is permitted to provide equipment and labor; however, minimum guidelines are suggested:

- All 110-volt wiring should be grounded three-wire.
- Wiring that touches the floor should be “SO” cord (minimum 14-gauge/three-wire) flat cord, which is insulated to qualify for “extra hard usage.” It is particularly important for exhibitors to use flat electrical cord in under-carpet installations.
- Cord wiring above floor level can be “SJ” which is rated for “hard usage.”
- Using zip cords, two-wire cords, latex cords, plastic cords, lamp cords, open clip sockets, and two-wire clamp-on fixtures is not recommended and is often prohibited. Cube taps should be prohibited.
- Power strips (multi-plug connectors) should be UL approved, with built-in over-load surge protectors.
- Local code commonly requires access to electrical cords and connections along the back wall of exhibit booths; typically, the back 9 inches of the space should remain accessible for this purpose. (This would apply to all booth types with a back wall.)

To better understand electrical at exhibitions, see the CEIR article [Demystifying Electrical Services for the Exhibitor](#).

LIGHTING

It is important to remember that lighting issues need to be identified as early as possible during the move-in process so they can be addressed and corrected while the necessary equipment is still available on the show floor and booths can be accessed.

- No lighting, fixtures, lighting trusses, or overhead lighting are allowed outside the boundaries of the exhibit space. Exhibitors intending to use hanging light systems should submit drawings to the Organizer for approval.
- Lighting should not project onto other exhibits or exhibition aisles. Lighting, including gobos, should be directed to the inner confines of the booth space.
- Lighting that is potentially harmful, such as lasers, ultraviolet lights or flashing or strobe lights that can trigger photosensitive epilepsy should comply with facility rules and be approved in writing by the Organizer.
- Lighting that spins, rotates, pulsates, and other specialized lighting effects should be in good taste and not interfere with neighboring exhibitors or otherwise detract from the general atmosphere of the event.
- LED lights can be very bright yet generally generate less heat.
- Currently, some convention facilities are not allowing certain types of quartz halogen lighting fixtures in exhibits due to potential fire hazards.
- Reduced lighting for theater areas should be approved by the Organizer, the utility provider, and the

DEMONSTRATIONS

As a matter of safety and courtesy to others, exhibitors should conduct sales presentations, product demonstrations, press conferences and other media events in a manner which assures all exhibitor personnel and attendees of such in-booth events are within the contracted exhibit space and not encroaching on the aisles or neighboring exhibits. Any queue lines formed for exhibitor customer interaction must also be contained within the booth footprint. It is the responsibility of each exhibitor to arrange displays, product presentation, audio visual presentations, and demonstration areas to ensure compliance with all other previously listed rules and regulations. Exhibitors should be aware of, and adhere to, local regulations regarding fire/safety and environment.

Special caution should be taken when demonstrating machinery or equipment that has moving parts, cooking equipment with an open flame, or any product that is otherwise potentially dangerous. Exhibitors should establish a minimum setback of 3ft (.91m) and/or install hazard barriers as necessary to prevent accidental injury to spectators. Additionally, demonstrations should only be conducted by qualified exhibitor personnel.

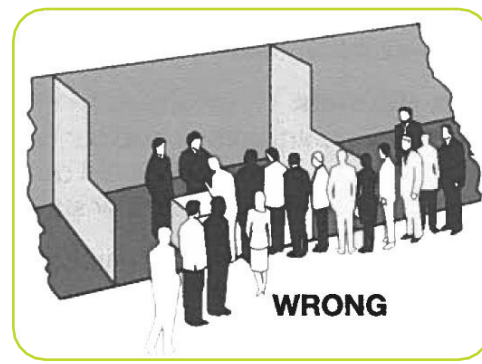
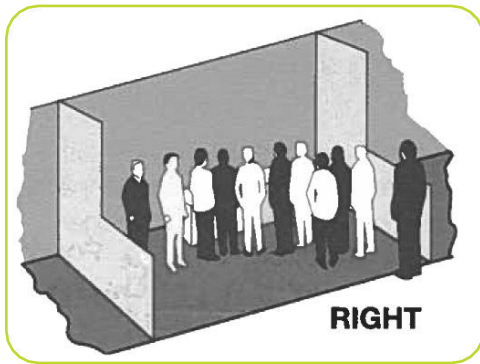

SOUND/MUSIC

In general, the use of sound equipment in booths is permitted as long as the noise level does not disrupt the activities of neighboring exhibitors. Speakers and other sound devices should be positioned to direct sound inward (to be contained within the booth) rather than outward (toward aisles and other exhibitor booths). Generally, sound and noise should not exceed 85 decibels when measured from the aisle immediately in front of a booth. If an exhibitor or attendee is standing within ten feet of an exhibitor's booth and cannot carry on a normal voice-level conversation, the noise source is too loud. (Refer to the U.S. Occupational Safety and Health Act [OSHA] at www.osha.gov for more information.)

Exhibitors should be aware that music played in their booths, whether live or recorded, may be subject to laws governing the use of copyrighted compositions. Authorized licensing organizations, including but not limited to [ASCAP](http://www.ascap.com), [BMI](http://www.bmi.com) and [SESAC](http://www.sesac.com), collect copyright fees on behalf of composers and publishers of music. It is the exhibitors' responsibility to be informed of copyright laws and submit fees to the appropriate organizations.

VEHICLES (FOR BOTH GAS AND ELECTRIC VEHICLES)

Rules for display vehicles vary widely depending on the facility and local fire and safety regulations. Compliance with fire, safety, the U.S. Americans with Disabilities Act (ADA), and other city, county, federal, and provincial government requirements is the responsibility of the Organizer.

Important Note: Always check with local exhibition service contractors and/or the facility for all requirements regarding display vehicles. Below are a few common examples of display vehicle regulations:

- Display vehicles must have battery cables disconnected and taped, and alarm systems deactivated.
- Fuel tank openings shall be locked or sealed in a manner to prevent escape of vapors through filler caps.
- Vehicles shall be limited in the amount of fuel that can remain in the tanks; specific amounts vary but one example is no more than one-quarter the tank capacity or a maximum of five gallons of fuel, whichever is less.
- Fueling or de-fueling of vehicles on the facility premises is prohibited.
- Once placed, display vehicles may not be started or moved without the approval and direction of show management.
- Auxiliary batteries not connected to engine starting system may remain connected. External power is recommended for demonstration purposes. No battery charging is permitted inside buildings.
- Combustible/flammable materials must not be stored beneath display vehicle. There may be no leaks underneath vehicles.
- It is not recommended that Organizers hold or take possession of display vehicle keys during the event. However, it is recommended that an official policy be established for the handling of vehicle keys which might include identifying booth contacts with mobile numbers should vehicles need to be moved in an emergency or some other unforeseen situation. Need to get guidelines for placing, displaying electric vehicles.
- Check with your facility regarding any weight load limits.
- Show organizers should request information from exhibitors in advance of the show if they are bringing in a vehicle. Usually 45 days is the standard.

ADVISORY NOTES TO EXHIBITION

FIRE EQUIPMENT

Fire hoses, extinguishers, and audible or visual devices for fire alarms should be visible and accessible at all times.

HANGING SIGNS

Although these Guidelines indicate 16ft to 20ft (4.88m to 6.10m) as a maximum height range to the top of the sign, some exhibitions permit other heights, or have no height limit. However, most Organizers do impose height limits. Caution should be exercised so exhibitors will not compete over air space for

Exhibitors should be advised to install “hanging points” at the time of manufacture of the sign or display. It is also advisable to have Hanging Signs labeled and cased separately so that they can be easily identified on-site as they usually must be installed before other exhibit construction can begin.

Recommend checking with facilities regarding some areas of exhibit hall that may not have points available to alert exhibitors.

HARDWALL BOOTHS

Exhibitions that provide Hardwall Booths should specify if these structures can be used for display and attaching products.

PERIMETER OPENINGS

Local fire and/or facility regulations may require larger exhibit booths to have a certain number of openings within the perimeter walls for safe egress. Regulations vary with each location, but one example would be to provide, at a minimum, one 6ft (1.83m) wide opening every 30ft (9.14m).

PIPE AND DRAPE

These are commonly used at exhibitions and events in the United States to define exhibit space. Organizers also may note which size booths and configurations will be provided with pipe and drape. Organizers often include in their rules and regulations that this equipment is not intended as a display fixture. Therefore, product and signs should not be attached or affixed. Measurements of booths must allow for size of pipe on sides and back.

PRODUCT HEIGHT

Some exhibitors have products that exceed display height restrictions. Organizers should establish guidelines for displaying such products. For example, some exhibitions or events require that these exhibitors reserve only perimeter space. Products exceeding height restrictions for Islands and Peninsulas are usually permitted, providing they are displayed in operating mode, and the names and logos, etc. on the product are as it is sold. NOTE: Any special height variances allowed should apply only to those products represented, produced or manufactured by the exhibitor and would not apply to ancillary display or marketing items (such as promotional flags, signs, etc.).

HEIGHT VARIANCES

Height Variances may be issued for all types of booths. However, in a Linear Booth, the back side of any structure over 8ft (2.44m) must be free of trademarks, graphics and/or logos. Tall flags or markers on the front aisle of Linear Booths are prohibited. Pop up tents or canopies may be allowed but must follow all local fire and facility regulations.

ENVIRONMENTAL RESPONSIBILITY

Exhibitions and events, by their very nature, create waste. Properly managed, exhibitions and events can recycle excess materials and supplies in useful and meaningful ways, and they can do so using methods that result in minimized impact on the environment. Exhibits should utilize recycled, renewable and energy efficient materials whenever possible. Exhibitors planning to dispose of, or leave behind, any property from their booth must make arrangements with the Official Services Contractor for disposal and all appropriate and applicable fees will apply.



White Paper: Evaluating and Implementing Cubic Content into Linear Exhibit Space

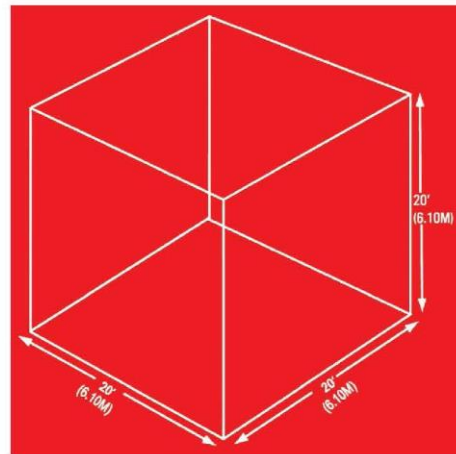
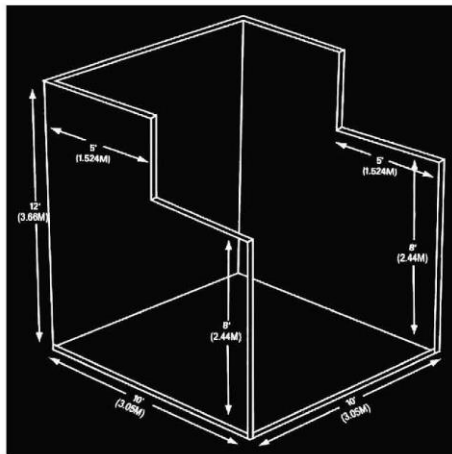
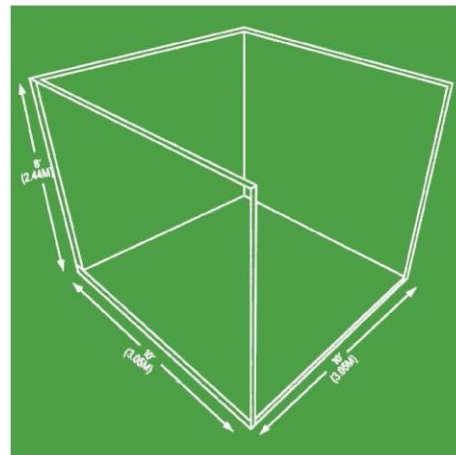
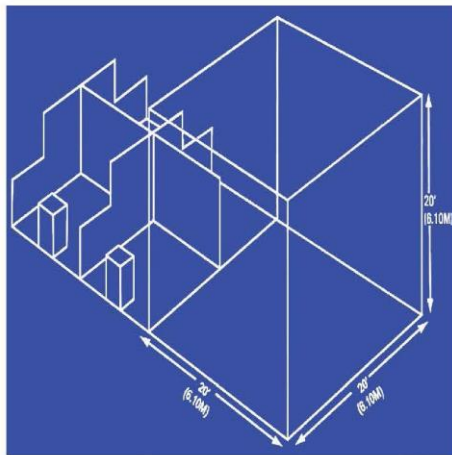

WHITE PAPER: EVALUATING AND IMPLEMENTING CUBIC CONTENT INTO LINEAR EXHIBIT SPACE

Table of Contents

Introduction.....	2
Research.....	2
Use of Cubic Content.....	2
International Exhibitions vs. US Exhibitions – Display Guidelines	3
Reasons to Consider.....	3
Key Responses from Exhibition Organizers Allowing Cubic Content (11 of 33 responses) – In Their Own Words.....	3
Exhibition Organizers Who Do Not Allow Cubic Content (22 of 33 responses) – In Their Own Words	4
Hardwall, Fabric, Portable, Modular, Table Top Displays, Pipe & Drape – Living Together.....	5
Floor Plan Layouts to Accommodate Linear Cubic Content Booths – Special Layouts	5
Cubic Content for Products	5
Equipment/Display Material: The following is an example of display rules for a specific type of item:.....	5
Perspective	5
Sample of Cubic Content Display Guidelines (Provided by Messe Frankfurt)	6

WHITE PAPER: EVALUATING AND IMPLEMENTING CUBIC CONTENT INTO LINEAR EXHIBIT SPACE

Introduction

IAEE presents the following white paper as an academic briefing without recommendation regarding the use of full cubic content for linear exhibit space and its potential impact on the exhibitions and events industry. As it pertains to exhibition booths, cubic content is a unit of measurement allowing display materials and products to occupy 100 percent of the exhibit space purchased, regardless of sightlines, up to a height established by the exhibition's rules.

It is the responsibility of the exhibition organizer to establish rules to best achieve the goals for its exhibition. Based on the nature of the exhibition, it is ultimately the choice of the exhibition organizer whether to allow use of full cubic content in linear exhibit space, or to observe the line-of-sight set-back rule. IAEE's publication, *Guidelines for Display Rules and Regulations* is intended to be viewed as guidelines, and not rules.

This white paper addresses the dynamics involved in the likelihood that as more international exhibitors participate in U.S.-based events, the expectations for cubic content availability will also increase. Thus the questions are:

- How can this new trend best be met, if at all?
- What methods might be employed to allow dual usage of both cubic content booths and line-of-sight booths?
- What are the advantages/disadvantages of doing so?

Further, many exhibitions and events today already allow for cubic content, primarily due to the nature of the industry sector it serves. It is prudent for the exhibition organizer considering cubic content for their exhibitions to review the concerns, advantages and disadvantages prior to putting cubic content guidelines into practice.

Research

IAEE requested feedback and input from its members from which 10 responses were received. Task force members then conducted telephone interviews with 35 show organizers whose organizations represent various industry sectors. Additional information was gathered through comments from the EDPA LinkedIn online discussion group. The responses are reflected in this document as to the advantages, disadvantages, international exhibitors, etc.

Use of Cubic Content

Under the current IAEE *Guidelines for Display Rules and Regulations*, cubic content, as it pertains to exhibitions and events, generally allows an exhibitor utilizing island space (a minimum of four 10' x 10' booths, open on four sides), to occupy 100 percent of the island space with both product and display materials. Regarding linear booths, it states "It is common at certain types of exhibitions to eliminate the line-of-sight requirement for Linear, End-Cap, and Peninsula Booths that back up to Linear Booths. This permits exhibitors to utilize the full cubic content of the booth." A Split Island Booth may also be allowed to utilize full cubic content of the booth when it backs up to another Split Island Booth.

The IAEE Guidelines for Display Rules and Regulations are not rules. Therefore some organizers have revised the Guidelines to fit their own needs as it pertains to cubic content and other guidelines. For instance, some heavy equipment exhibitions, for safety purposes, may require a setback of nine to twelve inches from the aisle line to prevent tripping. Others may require a 20 percent sightline of island booths.

For the purpose of this document we will restrict comments to construction and use of linear space. Many organizers today are permitting use of cubic content in linear booths because either their exhibitors find cubic content to be beneficial to their display, or because they want international exhibitors to feel welcome. It also reduces the need to police exhibits to enforce setback rules. The IAEE *Guidelines for Display Rules and Regulations* do not suggest cubic content should be implemented for linear booths; however cubic content in a linear booth is acceptable when the organizer has advantageous reasons to allow it. Prior to putting cubic content into practice, exhibition organizers must be proactive in communications with exhibitors, and understand the effect it will have on the exhibition. This document contains feedback from show organizers who allow use of cubic content in linear booths and those who do not. The intent is to assist a show organizer in making the best decision for their show.

WHITE PAPER: EVALUATING AND IMPLEMENTING CUBIC CONTENT INTO LINEAR EXHIBIT SPACE

International Exhibitions vs. US Exhibitions – Display Guidelines

Most European exhibitions and other countries allow the use of cubic content. Larry Kulchawik, senior vice president of 3D Exhibits, Inc., says, “Not all rules, styles, and customs are the same from country to country ... this is only one part of the country differences in trade show marketing, but a big one.”

Cubic Content for linear booths in the U.S. is not as popular as it is in other countries, but more and more U.S. organizers are finding it necessary to allow cubic content in linear booths for the sake of attracting and accommodating international exhibitors. Many U.S. exhibitions have government-sponsored international pavilions that typically are island spaces, back-to-back booths or booths facing each other with an aisle between. Depending on the type of space, these pavilions often are allowed to utilize full cubic content in the U.S.

International exhibitors occupying linear space sometimes bring in their own display house to help them conform to the U.S. display guidelines. The difference between U.S. display regulations and their country’s regulations, such as cubic content, square meters and square feet can be perplexing to a show’s new international exhibitor.

“Some clients want to capture the clientele in an enclosed stand and generally these clients have invitations in advance of the show so they have an appointment. Others prefer to enclose their stand to immerse the potential viewers in an experience. What better way than to take away the distraction of the other stands. Those that choose the open feel are trying to educate potential customers or get their corporate identity out there for everyone to see,” Mac Kieltyka, project manager of Creative Solutions Group.

Reasons to Consider

Aside from accommodating international exhibitors, or the belief that cubic content is more conducive to certain types of product displays or experiences, the fact is, today’s exhibitors want more return on their investment. Many exhibitors feel they should be able to utilize all the space they have paid for without a five-foot setback rule. Exhibitors want to display their products in a structure or setting that is best suited toward maximizing their investment. Ultimately it is the show organizer who will decide whether cubic content is a practical display regulation.

Key Responses from Exhibition Organizers Allowing Cubic Content (11 of 33 responses) – In Their Own Words

“With the exception of one or two shows, all are cubic content. We have utilized cubic content for years and feel it gives our customers more value for their money by allowing them to use more of their space. The one or two shows we do not use cubic content on, we rarely get any push back and those shows do have an international presence. What feedback we do get (which is minimal) is typically centered on obstructions from a neighboring booth. These objections often come from those who have not read our exhibitor manual where cubic content is prominently addressed.”

“We have already implemented it for all nine shows we run in North America. Linear Booth Use of Space: Shows allow exhibitors full “Cubic Content” use of the exhibit space. Therefore, you are allowed to place displays or materials at the full eight foot (2.44m) height throughout the entire width and depth of your exhibit space. Perimeter Booth Dimensions and Use of Space: All guidelines for Linear Booths apply to Perimeter Booths except that the maximum back wall height is 12ft (3.66m). There were a few complaints initially, but they were a minority and have now stopped. We make sure to explain the rules clearly to new exhibitors and to remind everyone frequently. We implemented this because it made it more consistent for our international exhibitors from around the world, and eliminated the majority of our set-up issues onsite (which are mostly due to sightline issues).”

“Our exhibition allows for the use of the cubic content of exhibit spaces. The feedback has been overwhelmingly positive. Most companies exhibit in some international shows. They appreciate the consistency of having the same rules and also see the common sense approach to allow exhibitors to use all their space. And, since it is fully implemented, it is fair for all. We allow cubic content in all areas.”

WHITE PAPER: EVALUATING AND IMPLEMENTING CUBIC CONTENT INTO LINEAR EXHIBIT SPACE

"We do have an abbreviated cubic content rule for islands and split islands. The entire cubic content of the space may be used up to the maximum allowable height; however exhibitors must follow the line-of-sight guidelines (20 percent) listed above. The line-of-sight guideline referenced above states: All booths regardless of size or type should be designed in such a way so as to eliminate line-of-sight obstructions from one exhibit to the next. A solid wall or banner between an island or split-island booth and a row of linear booths (particularly along the perimeter) is inappropriate. This is particularly important along shared walls and borders between linear and split-island exhibits. If you are planning a hardwall installation that could obstruct the view to neighbors' booths, a booth variance form and schematic must be submitted for review. **NEW** – All island booths regardless of size should allow 20 percent of visibility on all sides excluding the shared back wall. Examples: 20' x 20' Island: each side of the booth must have visibility for a minimum of 4'. 30' x 40' Island: the 30' sides of the booth must allow visibility for a minimum of 6'; the 40' sides of booth must allow visibility of 8'. Exhibitors may use Plexiglas or similar material to create a wall that will allow for line-of-sight from one booth to the next.

The linear 10' x 10's have a harder time understanding that they must follow the standard IAEE rules allowing for no product or displays over 4' tall in the front half of the booth. We have had this guideline in place for about three years now, but have always allowed them to receive a variance if their theaters, meeting rooms, etc., did not allow for this amount of line-of-sight. However, at this time we are telling exhibitors that we will be enforcing the rule for the 2012 show. Our exhibitor advisory committee requested that we begin enforcing the rule for next year."

"Exhibitors are to show respect for fellow exhibitors and fire marshal rules must be met – island exhibits and linear."

"Yes, exhibits can be closed on three sides for linear booths, totally closed in for islands."

"We approve on a request-only basis. Show is less than 10 percent cubic content exhibits."

"We will allow cubic content for booths that are against an outside wall that do not have adjacent booths/neighbors."

Exhibition Organizers Who Do Not Allow Cubic Content (22 of 33 responses) – In Their Own Words

"We do not like the reduced sightlines that this would create."

"We feel it is important to protect sightlines. We spend time communicating with them (international exhibitors) to try to set expectations before they arrive for the show."

"Most overseas exhibitors want to comply with line-of-sight rules when they exhibit in the U.S; however, some request cubic content and those requests are granted. No complaints from neighbors."

"While the cubic approach to booth content may eliminate some issues and policing, we believe in the line-of-sight good neighbor policy. If exhibitors want to use cubic content for their booth, they can purchase an island."

"Unfair to our small exhibitors that depend on a fair sightline into their booth."

Note: All other exhibition organizers interviewed said they use the line-of-sight in the *IAEE Guidelines for Display Rules and Regulations*.

WHITE PAPER: EVALUATING AND IMPLEMENTING CUBIC CONTENT INTO LINEAR EXHIBIT SPACE

Hardwall, Fabric, Portable, Modular, Table Top Displays, Pipe & Drape – Living Together

There are many different types of displays used in exhibitions. If the organizer chooses to allow cubic content in linear booths, the organizer needs to be aware of the responsibility to communicate the rules clearly to all exhibitors so there are no surprises on site. A portable exhibit may only extend five feet out from the backwall but its neighbor may have hardwall at eight-foot height out to the aisle line. The portable exhibit must be aware the sightline will be impacted and the hardwall exhibitor must be sure the backsides of the panels are finished. This is true with all exhibits in a linear space cubic content exhibition. If the rules allow for cubic content in linear spaces, then it is a fair environment for all to choose how they wish to use that space; but communication is key to a smooth operation.

It is rare to expect a U.S. exhibition or its general service contractor, to provide hardwall for all exhibitors; however, exhibitions using all hardwall do exist in the U.S.

Floor Plan Layouts to Accommodate Linear Cubic Content Booths – Special Layouts

None of the show organizers interviewed indicated a need for a split floor plan, i.e., certain areas of the floor are designated for linear cubic content booths.

Cubic Content for Products

Some exhibition organizers allow products to exceed the four-foot high rule five feet in from the aisle line. Others do not and strictly enforce the sightline setback. The types of products displayed may determine whether an organizer chooses to permit products only (not booth structure) to occupy the cubic content of a linear booth. However, for example, if the product is banner stands that are eight feet or 10 feet tall, a row of banner stands at the aisle line may be very intrusive to a neighbor. On the other hand, a piece of machinery that is six feet tall may not cause a major problem. Exceptions may also depend upon the size of a booth such as 10' by 20' versus 10' by 10'. Under certain circumstances, an organizer may prefer to make the exception a variance, subject to show management review and approval. This option provides the organizer more control if product is an exception to the set-back guidelines.

Equipment/Display Material: The following is an example of display rules for a specific type of item:

- SPECIAL PROVISIONS: Pedestals, tables, racks, shelves, risers and similar display equipment may not exceed 42" in height when positioned more than 5' from the back wall of a single-aisle exhibit booth space or the center line of a three-aisle exhibit booth space, unless the same company occupies 8' of exhibit booth space on both sides of the unit or units. The maximum height for such items under these circumstances, including the product being displayed, is 66". Free-standing units, including those intended to be the focal point in an exhibit, may not exceed 42" in height when placed more than 5' from the back wall of the exhibit booth space unless the same company occupies 8' of exhibit booth space on both sides of the unit or units. The maximum dimensions for such items under these conditions are 8' high x 32" wide x 32" deep.

Perspective

It is inevitable that exhibition organizers will have varying thoughts and opinions about allowing exhibitors to have full use of the cubic content space within their linear booth. Just as there are many different opinions as to whether end cap booths are permissible in floor plan layouts due to the somewhat difficult situations they often times create, the exhibition organizer must make the determination as to what is best for their exhibition.

It is often wise to consult with an exhibition's Exhibits Advisory Board. Alternatively, an organizer may consider conducting a focus group of the exhibition's exhibitors to determine their interest and gain their feedback.

A linear space exhibitor utilizing cubic content for the first time may also experience some higher costs. If they bring a hardwall display that reaches 8' high for three sides of their exhibit, when in the past they utilized a fabric display, obviously their labor, shipping and drayage costs will be higher. However, that is the decision of the exhibitor if the exhibition organizer is allowing cubic content for linear displays and the exhibitor chooses to take advantage of the space in this fashion.

WHITE PAPER: EVALUATING AND IMPLEMENTING CUBIC CONTENT INTO LINEAR EXHIBIT SPACE

Sample of Cubic Content Display Guidelines (Provided by Messe Frankfurt)

Linear Booth

Linear Booths have only one side open to an aisle and are generally arranged in a series along a straight line. They are also called “in-line” booths. Floor covering is required in all rented space.

Dimensions

For purposes of consistency and ease of layout and/or reconfiguration, floor plan design in increments of 10ft (3.05m) has become the de facto standard in the United States. Therefore, unless constricted by space or other limitations, Linear Booths are most commonly 10ft (3.05m) wide and 10ft (3.05m) deep, i.e. 10ft by 10ft (3.05m by 3.05m), with a maximum back wall height limitation of 8ft (2.44m).

Use of Space

Messe Frankfurt Shows allow exhibitors full “Cubic Content” use of the exhibit space. Therefore, you are allowed to place displays or materials at the full 8 ft. (2.44m) height throughout the entire width and depth of your exhibit space.

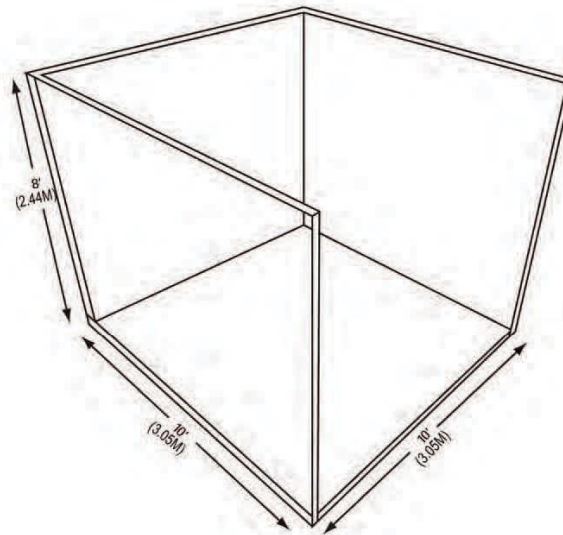

LINEAR BOOTH (10' X 10') (3.05m x 3.05m)

Corner Booth

A Corner Booth is a Linear Booth exposed to aisles on two sides. All other guidelines for Linear Booths apply.

WHITE PAPER: EVALUATING AND IMPLEMENTING CUBIC CONTENT INTO LINEAR EXHIBIT SPACE

Sample of Cubic Content Display Guidelines (Provided by Messe Frankfurt)

Perimeter Booth

A Perimeter Booth is a Linear Booth that backs to an outside wall of the exhibit facility rather than to another exhibit. Floor covering is required in all rented space.

Dimensions and Use of Space

All guidelines for Linear Booths apply to Perimeter Booths except that the maximum back wall height is 12ft (3.66m).

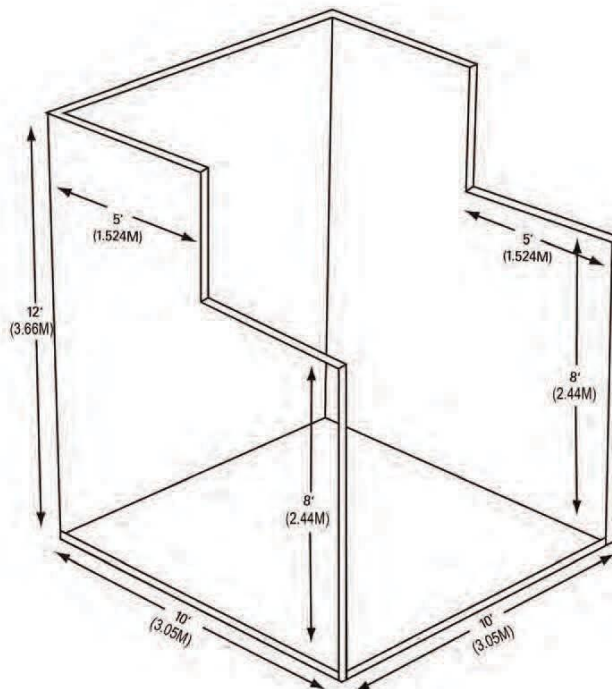

PERIMETER BOOTH (10' X 10') (3.05m x 3.05m)

WHITE PAPER: EVALUATING AND IMPLEMENTING CUBIC CONTENT INTO LINEAR EXHIBIT SPACE

Sample of Cubic Content Display Guidelines (Provided by Messe Frankfurt)

Peninsula Booth

A Peninsula Booth is exposed to aisles on three (3) sides and is a minimum of 20' x 20' (6.10m) in size. Floor covering is required in all rented space.

Dimensions

A Peninsula Booth is usually 20' x 20' (6.10m x 6.10m) or larger. Twenty feet (20') (6.10m), including hanging signage, is the maximum height allowed throughout the booth space. The connecting wall between the peninsula booth and any neighbors must be "finished off" (clean and presentable to visitors) on the side facing the connecting neighbors.

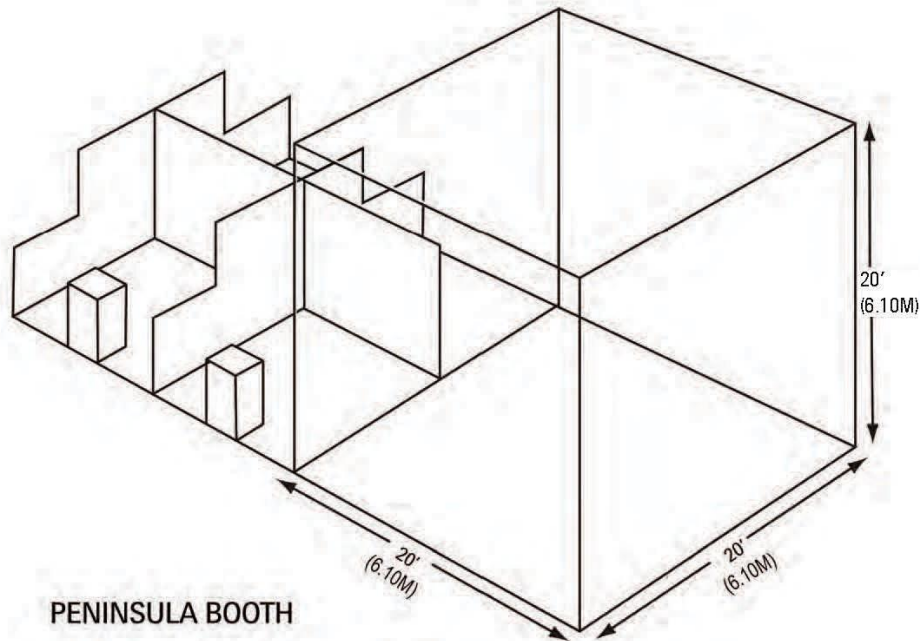

WHITE PAPER: EVALUATING AND IMPLEMENTING CUBIC CONTENT INTO LINEAR EXHIBIT SPACE

Sample of Cubic Content Display Guidelines (Provided by Messe Frankfurt)

Island Booth

An Island Booth is any size booth exposed to aisles on all four sides. Floor covering is required in all rented space.

Dimensions

An Island Booth is typically 20' x 20' (6.10m x 6.10m) or larger.

Use of Space

The entire cubic content of the space may be used up to the maximum allowable height of twenty feet (20') (6.10m), including any hanging signage.

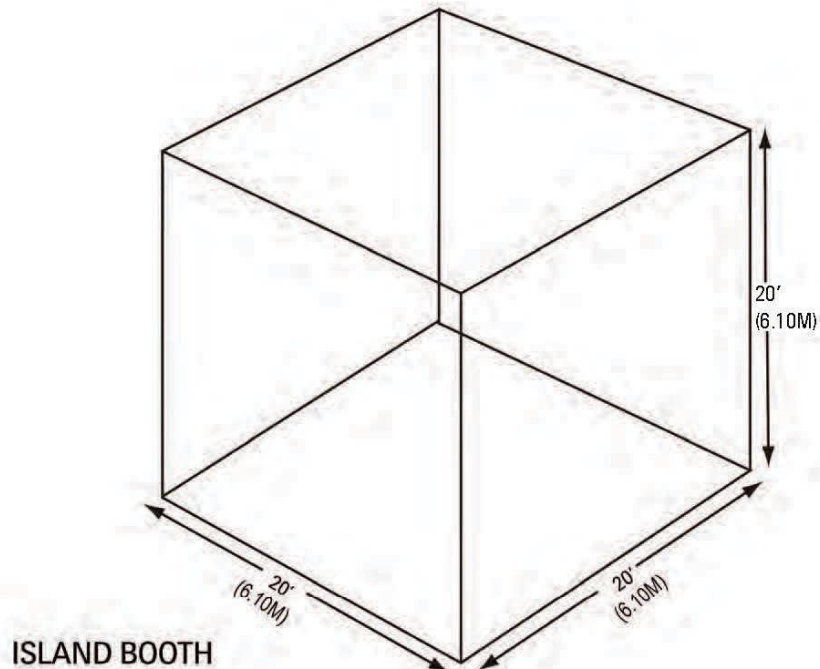

WHITE PAPER: EVALUATING AND IMPLEMENTING CUBIC CONTENT INTO LINEAR EXHIBIT SPACE

IAEE appreciates the efforts of the Cubic Content Task Force in developing this White Paper:

Carol Fojtik, CEM, Chair
Robert C. Brice
Thomas C. Corcoran
Kevin Johnstone
Martin Moggre, CEM
Pamela Kay Pietrok
Paul Prince, CEM
Chuck Schwartz, CEM
Barry Siskind
Julie Anderson, CEM, CAE, Staff Liaison
Terri Phillips, Staff Assistant

Additional appreciation goes to the following organizations that contributed relevant content for this white paper.

American Society of Mechanical Engineers
Association of Equipment Manufacturers
Corcoran Expositions
Distribution Solutions Conference
ExpoNation LLC
Home Builders Show
IMN Solutions
InfoComm
International Association of Fairs and Expositions
Messe Frankfurt
National Association of Broadcasters
National Restaurant Association
Reed Exhibitions

IAEE EXTENDS A SPECIAL THANK YOU TO THE FOLLOWING VOLUNTEERS FOR THEIR INPUT:

Russell Wingard, CEM
Vice President, Client
Solutions Freeman

**Frank
Sheridan**
Principal

2023 MATSO

John Rozum, Chairperson
Senior Director, Ag & Utility Exhibitions and
Events Association of Equipment
Manufacturers

Lisa Malikow, Vice Chairperson
Senior Vice President, Event Operations &
Programming National Restaurant Association
Show/Winsight Media

**Mark Bogdansky, Immediate Past
Chairperson**
Vice President, Meetings &
Events Auto Care
Association

Melodie Anderson, CEM, DES
Director of Meeting and Exhibit
Experiences Institute of Food
Technologists

Kate Hawley, CEM
Senior Manager, WEFTEC
Exhibition Sales Water Environment
Federation

Nath Morris, CEM
President, Expo
U.S. Poultry & Egg Association

Merideth Newman, CEM
Director, Expositions
The Association for Packaging and
Processing Technologies – PMMI

Gary Thuro
Chief Marketing & Sales
Officer RE+ Events

Ellen Tucker, CAE, MAS
Vice President of Revenue & Expositions
PPAI: Promotional Products Association
International

Jess Tyler, CEM
Chief Revenue and Experience Officer
at MJBiz A division of Emerald X, LLC